



IT_Descrizione prodotto

Divani

Caratteristiche tecniche

- Struttura:** - telaio multistrato di pioppo con struttura portante in metallo, cinghie elastiche su schienali.
- Molleggio:** - nastri elastici unidirezionali ad alta portata
- Imbottitura:** - poliuretano espanso ricoperto con resinato accoppiato vellutino.
- Meccanismo:** - meccanismo di traslazione schienale in metallo.
- Piedi:** - legno noce Canaletto o rovere tinto nero.
- Rivestimento:** - rivestimento in tessuto o in pelle.
Rivestimento in tessuto completamente sfoderabile.
- Opzione:** - fasce laterali in colore diverso.
- Note:** - All'ordine specificare tipo e colore fasce.

EN_Product description

Sofas

Technical features

- Frame:** - solid poplar wood and iron supports for backrest and frame. Elastic bands for backrest.
- Springing:** - high resistance unidirectional elastic bands
- Padding:** - polyurethane foam covered with heated bonded polyester fibre.
- Mechanism:** - backrest sliding mechanism in metal.
- Feet:** - Canaletto walnut or black dyed oak wood.
- Cover:** - fabric or leather cover.
Fabric cover is removable.
- Option:** - cover in different colour on sides
- Notes:** - On order please specify side cover color.

Piedi / Feet
Tavolino / Tray table

_Essenze
_Woods



_rovere tinto moka
_moka dyed oak



_noce canaletto
_canaletto walnut

Vibieffe

SINCE 1968

contact@vibieffe.com www.vibieffe.com

- B - Espanso densità portante / Foam supporting density
- C - Resinato / Heated bonded polyester fibre
- D - Espanso densità soft / Foam soft density
- E - Fusto in legno / Wooden frame
- F - Telaio in ferro / Iron frame

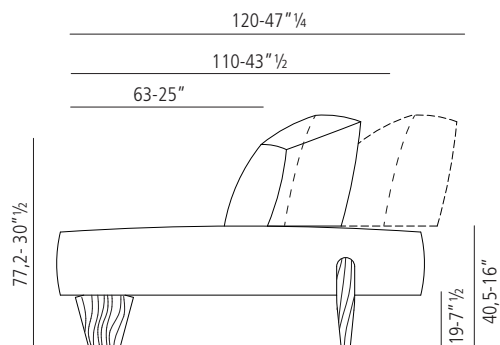
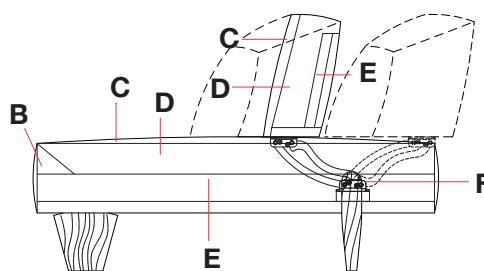

Vibieffe

SINCE 1968

contact@vibieffe.com www.vibieffe.com

cod 25002

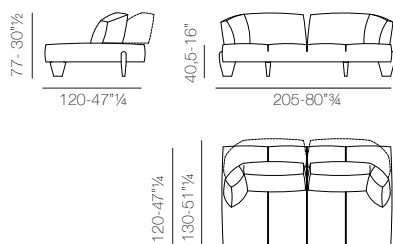

cod 25003

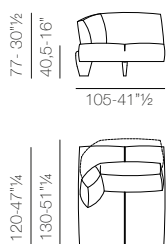

cod 25004

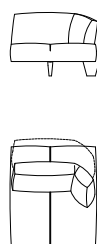

cod 25005

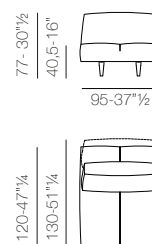

cod 25009

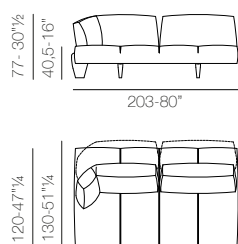

cod 25010

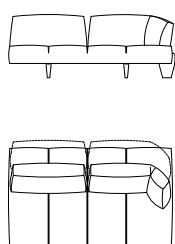

cod 250016/17

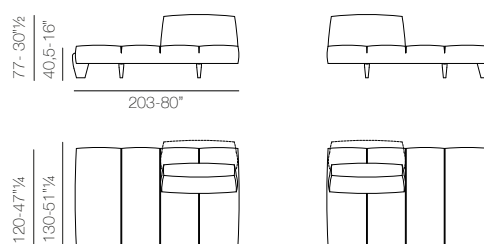

cod 25011/12

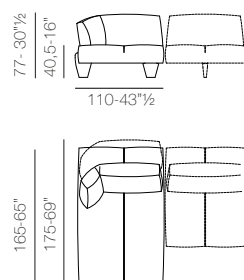

cod 25008

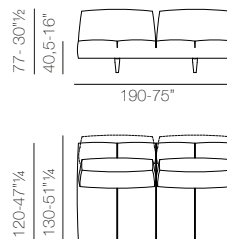

cod 25014/15

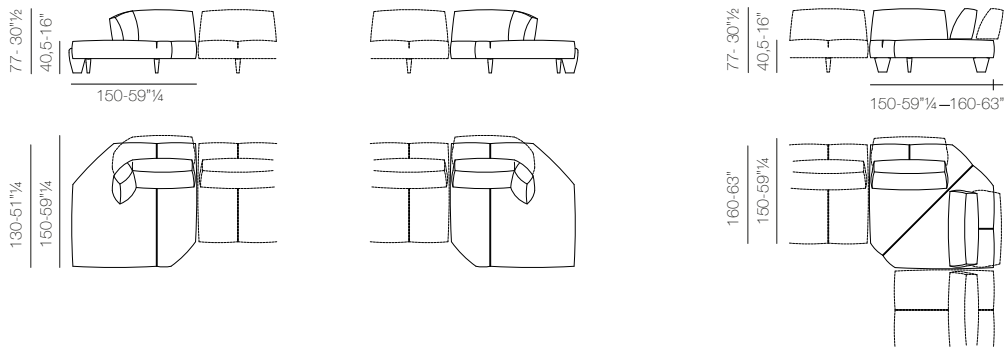

cod 25013

cod 25006

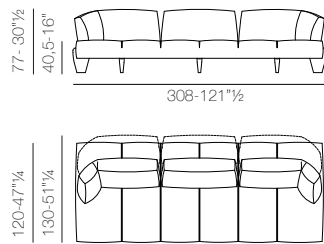

cod 25007

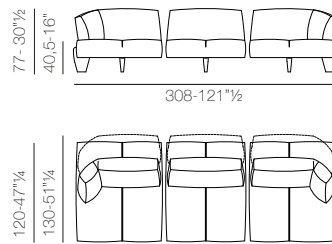

cod 25001

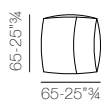

cod 25018

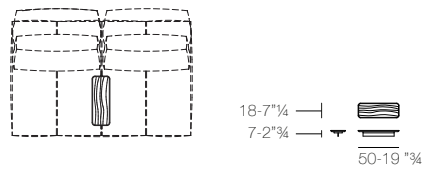

cod 25019

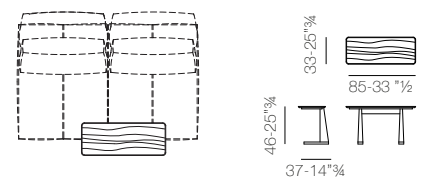



Vibieffe

SINCE 1968

contact@vibieffe.com www.vibieffe.com